

 **GOULDS PUMPS**

Goulds CV 3196 i-FRAME[®]

Non-Clog Process Pump with
i-ALERT[®] Patented Intelligent Monitoring



ITT

ENGINEERED FOR LIFE

CV 3196 i-FRAME®

Recessed Impeller Process Pumps Designed for Non-Clog Solids Handling

- Capacities to 2700 GPM (610 m³/h)
- Heads to 440 feet (134 m)
- Temperatures to 500°F (260°C)
- Pressures to 285 PSIG (1965 kPa)

Performance Features for Solids Handling Services

Extended Pump Life

- Concentric vortex casing for non-clog, minimum wear
- Recessed impeller for minimum solids degradation
- TaperBore™ / BigBore™ seal chambers
- i-FRAME® power ends

Ease of Maintenance

- Back pull-out design
- Parts interchangeable with Goulds Model 3196 i-FRAME®
- External impeller adjustment
- Easy retrofit

Safety

- ANSI B15.1 coupling guard
- Ductile iron frame adapter

Applications

- Filter slurries
- Latex
- Polystyrene beads
- Crystal suspensions
- Screen rejects
- Hydropulper pump
- Sodium chlorate slurry
- Fruit and vegetable suspensions
- Dye liquor
- Fibrous wastewater
- Long fibre white water
- Primary cleaner pump



CV 3196 i-ALERT® STi
(2 x 2-8)

The CV 3196 i-ALERT® is designed specifically to provide superior performance for process services containing solids. Goulds concentric vortex casing with recessed open impeller provides non-clogging capability with minimal solids degradation. In addition, the CV 3196 i-ALERT® can handle liquids entrained with air or gas.



CV 3196 i-ALERT® STi
(2 x-10, 3 x 3-10, 2 x 3-13, 3 x 4-13)
CV 3196 LTi (4 x 6-13)
CV 3196 XLTi (6 x 8-15)

Designed for Solids Handling Services

Not All Pumps Are Designed to Handle Certain Bulky /Fibrous or Shear Sensitive Solids

Conventional end suction pumps have close clearances between impeller and casing to maintain efficiency and performance. However, when handling certain bulky, fibrous solids, they can clog. In addition, high velocities in the casing cause increased wear, and can degrade or shear pumpage.

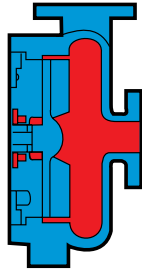
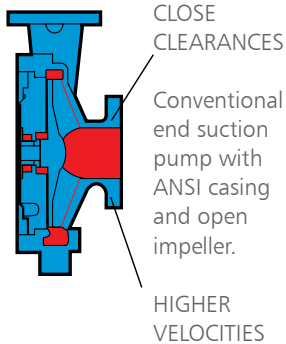

CV 3196 i-ALERT® end suction pump with circular volute casing and recessed impeller designed to prevent clogging and degradation of solids.

CV 3196 i-FRAME® Designed Specifically for Non-Clog Pumping with Minimum Solids Degradation

Since the induced flow or vortex impeller is recessed from the casing, velocities are low, and solids contact with the impeller is reduced, wear rate, solids degradation and shearing of liquid are minimized.

The casing design is well suited to handling solids in liquid suspension. Anything that can exit the discharge will pass through the pump.



Reduced Radial Loads

Trouble Free Operation At Low Flows

Many users throttle pumps to attain desired low flow performance. Because most pumps are not designed to operate continuously in this range, the resultant higher radial loads and increased shaft deflection lead to premature bearing and mechanical seal failure.

An added benefit of recessed impeller pumps is reliable operation at low flows. The CV 3196 uses a concentric casing which reduces radial loads by as much as 85% compared to end suction expanding volute pumps at low flows. Bearing, seal and overall pump life are optimized.

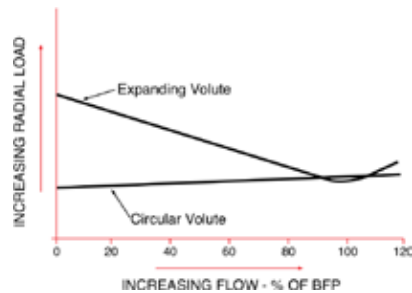

EXPANDING VOLUTE PUMP



CV 3196 i-FRAME® CIRCULAR VOLUTE PUMP

Easy Replacement or Retrofit Pump Replacement

Since the CV 3196 i-FRAME® foot mounting dimensions are the same as ANSI pumps, replacing ANSI pumps not designed to handle solids is simple... the inadequate pump is easily replaced by the appropriate size Model CV 3196 i-FRAME®.

The CV 3196 i-FRAME® uses all Goulds Model 3196 parts except casing and impeller, making pump retrofit and upgrade easy and economical.

A CV 3196 i-ALERT® retrofit kit (casing and impeller) easily converts an existing 3196.



CV 3196 i-FRAME®

Maximum Sealing Flexibility

To meet ANSI B73.1M specifications, Goulds provides the best choice of stuffing box or seal chamber and a wide range of sealing arrangements. Your Goulds representative will gladly recommend the best sealing solution for your service...some of which are illustrated below.

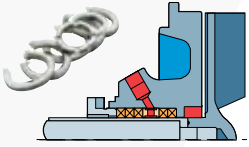

Packed Box

- PTFE-Impregnated Fiber Packing
- Standard Bore Stuffing Box

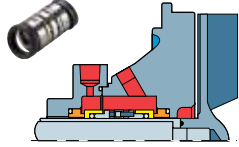

Conventional Double Seal

- BigBore™ Seal Chamber

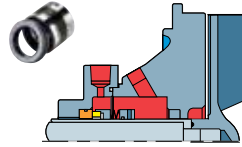

Single Inside Seal

- Stuffing box design
- Flush gland
- By-pass flush

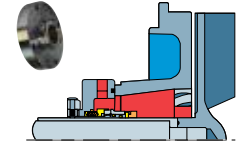

Single Cartridge Seal

- TaperBore™ PLUS Seal Chamber

Goulds i-FRAME® Power Ends

Designed for Reliability, Extended Pump Life

Condition Monitor



The heart of the i-FRAME®, the condition monitor unit continuously measures vibration and temperature at the thrust bearing and automatically indicates when pre-set levels of vibration and temperature have been exceeded, so that changes to the process or machine can be made before failure occurs.

A visual indication of pump health makes walk-around inspections more efficient and accurate. The result is a more robust process to monitor and maintain all your ANSI pumps so that your plant profitability is maximized. (i-ALERT®2 Bluetooth Equipment Health Monitor option available. See page 11 for more information.)

Inpro VBXX-D Hybrid Bearing Isolators

Most bearings fail before reaching their potential life. They fail for a variety of reasons, including contamination of the lubricant. INPRO VBXX-D has long been considered the industry standard in bearing lubricant protection. The i-FRAME® now improves upon that design by offering stainless steel rotors, for maximum protection against contaminants and the corrosive effects of seal leakage or environmental conditions. These seals are non-contacting and do not wear.

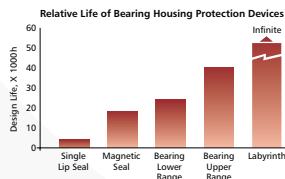

Shaft and Bearings Engineered for Maximum Reliability

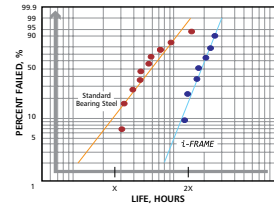

Fatigue life more than double that of conventional bearing steels.

Optimized Oil Sump Design

Internal sump geometry is optimized for longer bearing life. Sump size increased by 10% -20% results in better heat transfer and cooler bearings. Contoured design directs contaminants away from bearings, to the magnetic drain plug for safe removal.

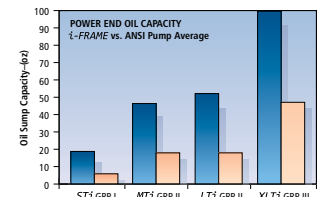
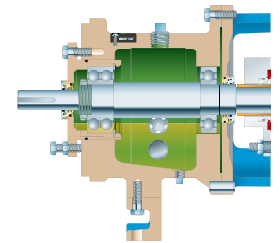

Larger Means Cooler
 GOULDS
 Industry Average

CV 3196 i-FRAME®

Dimensions

All dimensions in inches and (mm). Not to be used for construction.

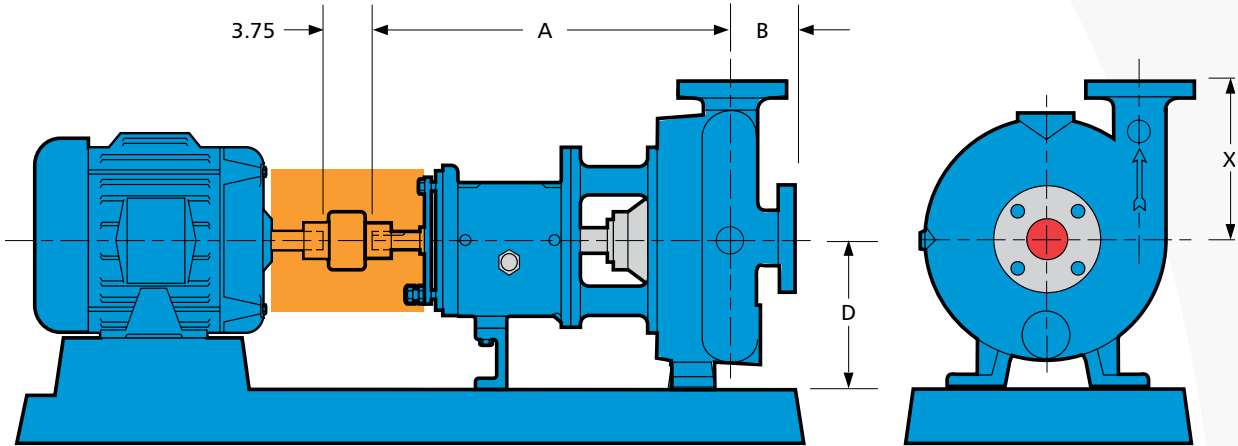

DIMENSIONS						
Group	Size	A	B	D	X	Bare Pump Weight Lbs. (kg)
STi	2x2-8	15.38 (391)	2.75 (70)	5.25 (133)	6.50 (165)	140 (65)
MTi/LTi	2x2-10	21.75 (552)	3.50 (89)	8.25 (210)	8.50 (216)	260 (120)
	3x3-10	22.50 (572)	4.25 (108)	8.25 (210)	9.00 (229)	280 (125)
	2x3-13	22.38 (568)	4.12 (105)	10.00 (254)	10.50 (267)	360 (165)
	3x4-13	22.81 (579)	4.12 (105)	10.00 (254)	10.50 (267)	410 (185)
LTi	4x6-13	23.13 (588)	4.75 (121)	10.00 (254)	11.50 (292)	430 (194)
XLTi	6x8-15	32.5 (826)	6.5 (165)	14.5 (368)	14.00 (356)	486 (219)

Baseplate Mounting Options

Goulds offers a complete range of mounting systems to meet plant reliability requirements, and to make alignment and maintenance easier.



CAMBER TOP CAST IRON

Rigid and corrosion resistant, it is preferred by many plants.

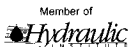

CHEMBASE PLUS™

Polymer concrete construction provides exceptional rigidity & corrosion resistance. ANSI 1991 dimensional.



FABRICATED STEEL

Economical baseplate that meets ANSI/ASME B73.1 M current edition dimensional requirements.



ENHANCED FEATURE FABRICATED STEEL

Upgraded ANSI baseplate designed to maximize pump operation life and ease installation by meeting API-minded chemical pump users toughest requirements.

CV 3196 i-FRAME®

Non Clog Process Pumps Featuring i-ALERT® Patented Monitoring

i-ALERT® CONDITION MONITOR

Constantly measures vibration and temperature at the thrust bearing. Colored LED's indicate general pump health. Provides early warning of improper operation before catastrophic failure occurs. (i-ALERT®2 Bluetooth Equipment Health Monitor option available. See page 11 for more information.)

INPRO VBXX-D HYBRID LABYRINTH SEALS

Prevents premature bearing failure caused by lubricant contamination or loss of oil. Stainless steel rotors for optimal performance in corrosive environments.

CONTINUOUS PERFORMANCE

Original flow, pressure and efficiency are maintained by simple external adjustment resulting in long-term energy and repair parts savings.

PREMIUM SEVERE-DUTY THRUST BEARINGS

Increase bearing fatigue life by 2-5X that of conventional bearing steels.

HEAVY DUTY SHAFT & BEARINGS

Rigid shaft designed for minimum deflection at seal faces – less than 0.002 in. (.05 mm). Bearings sized for 10-year average life under tough operating conditions. Available with or without shaft sleeve.

OPTIMIZED OIL SUMP DESIGN

Increased oil capacity provides better heat transfer for reduced oil temperature. Bearings run cooler and last longer. Contaminants directed away from bearings to magnetic drain plug.

ONE-INCH BULL'S EYE SIGHT GLASS

Assures proper oil level critical to bearing life. Can be mounted on either side of pump for installation flexibility.

Designed for reliability and extended pump life, backed with a 5-year warranty.

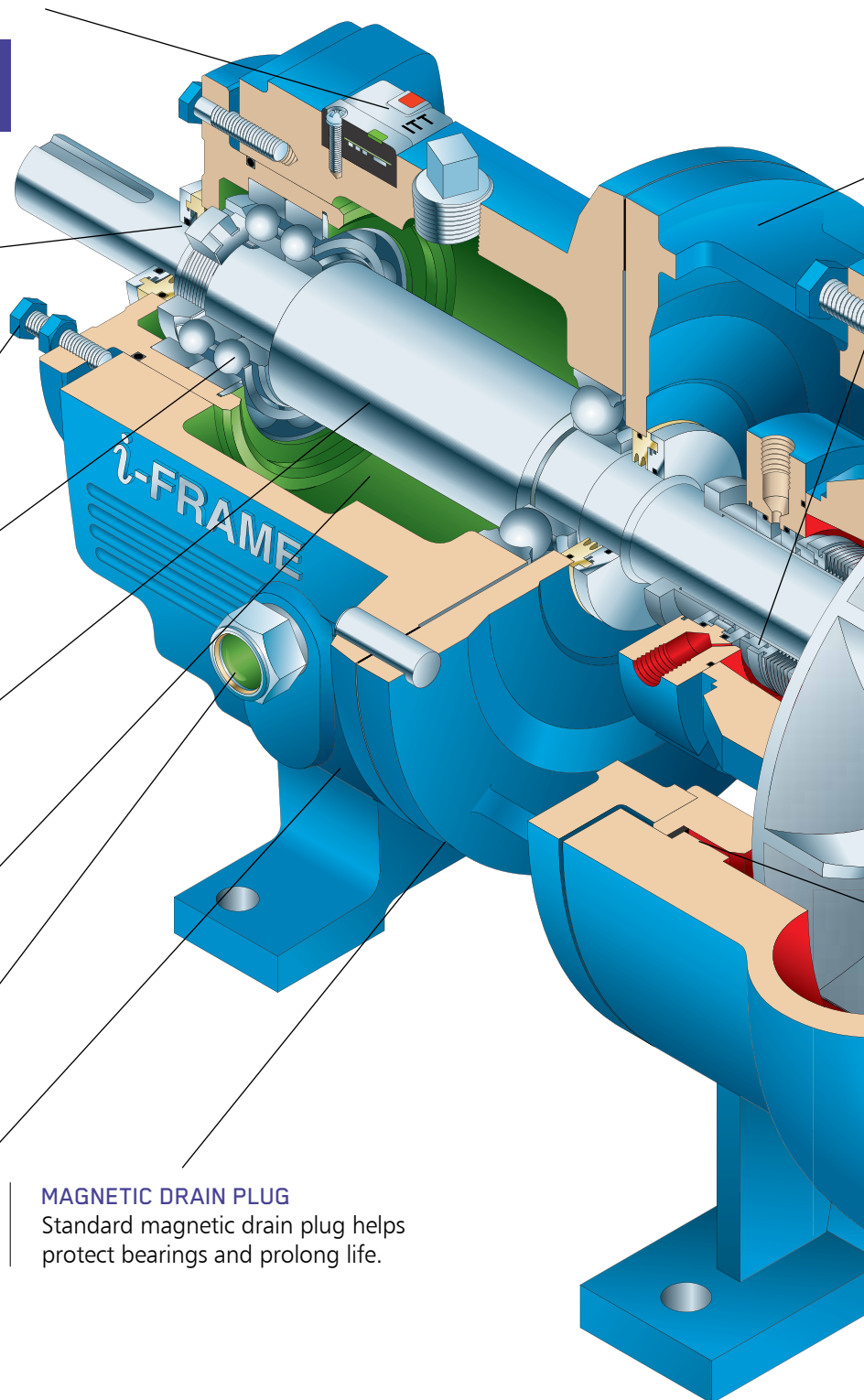

MAGNETIC DRAIN PLUG

Standard magnetic drain plug helps protect bearings and prolong life.

SEALING FLEXIBILITY

Wide range of sealing arrangements available to meet service conditions. Engineered seal chambers improve lubrication and heat removal (cooling) of seal faces for extended seal life and pump uptime.

DUCTILE IRON FRAME ADAPTER

Material strength equal to carbon steel for safety.

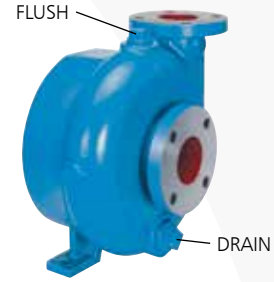

OPTIONAL FLUSH & DRAIN CONNECTIONS

Provide capability to clean impeller and casing without disturbing piping. Scheduled maintenance is easy.

NON-CLOG CIRCULAR CASING

Large open passageways prevent clogging when handling bulky, stringy or fibrous liquids. Circular volute reduces radial loads during low flow operation.

RECESSED IMPELLER

Since impeller is recessed from casing, velocities are low and solids contact with impeller is reduced. Wear rate, solids degradation and shearing of liquid are minimized. Liquids containing significant entrained air or gas can also be pumped.

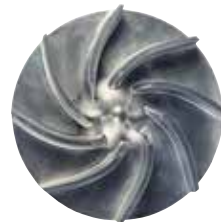

SERRATED FLANGES

For positive sealing against leakage. Meets ANSI B16.5 requirements. Class 150 FF standard.

POSITIVE SEALING

Assured by renewable, confined PTFE envelope casing gasket. Compressible filler assures positive seal with low bolt load and without need for retightening.

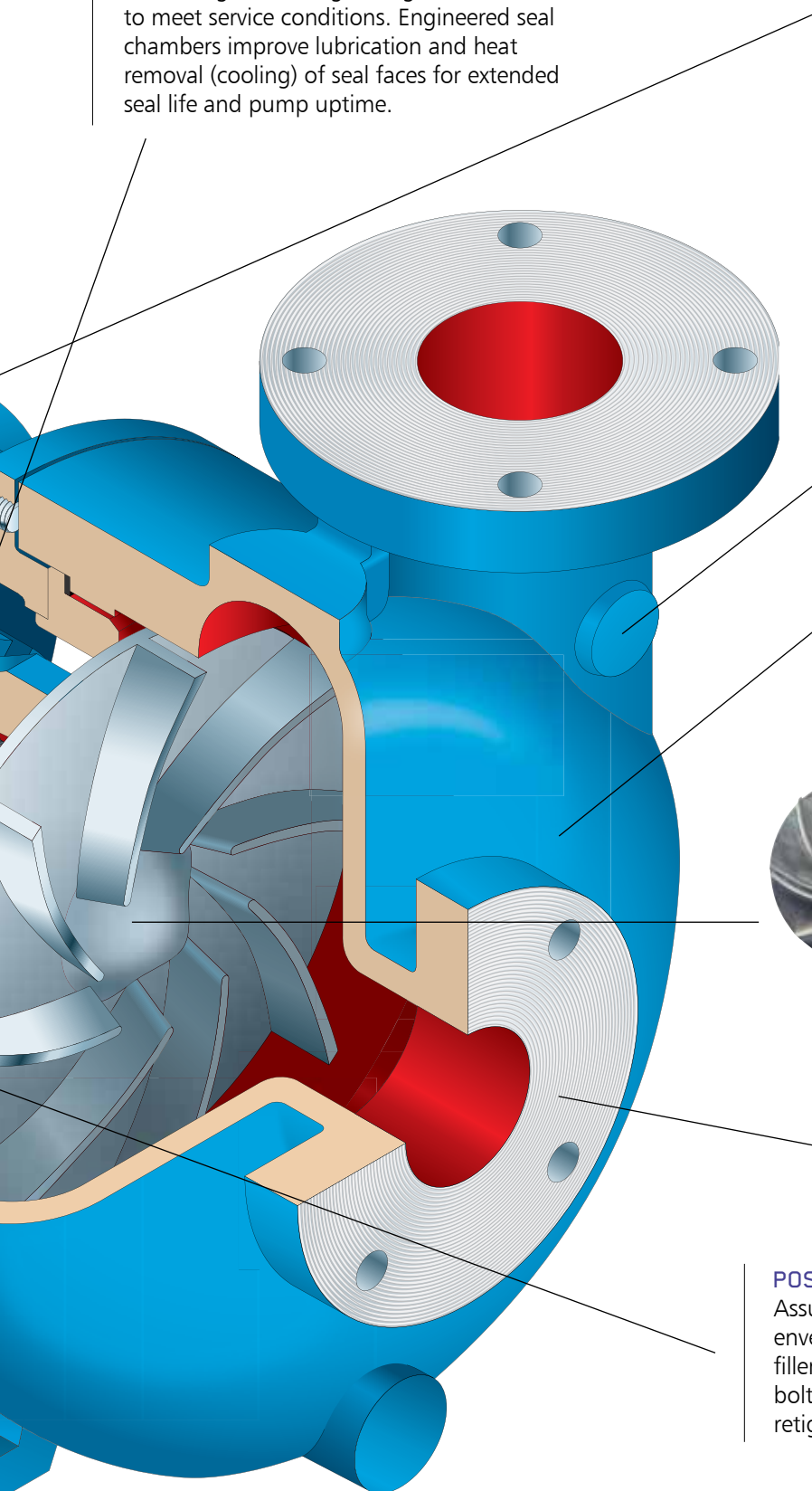

CV 3196 i-FRAME®

Sectional View

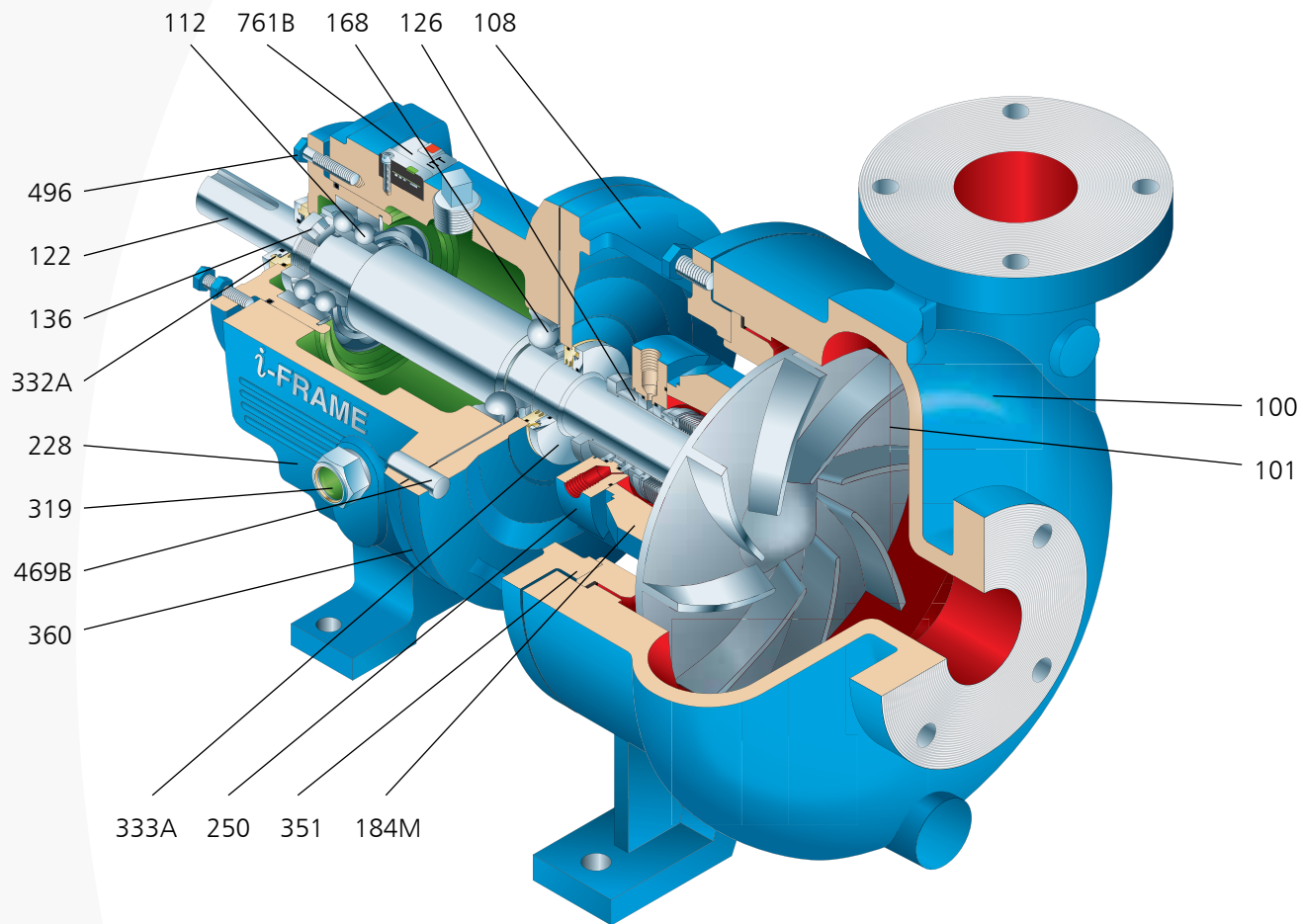

Bonus Interchangeability

i-FRAME® Power Ends Fit 7 Different Process Pumps

Minimize inventory, reduce downtime.



3196 i-FRAME®
Process Pumps

CV 3196 i-FRAME®
Non-Clog
Process Pumps

HT 3196 i-FRAME®
High Temperature
Process Pumps

LF 3196 i-FRAME®
Low Flow ANSI
Process Pumps

3198 i-FRAME®
PTFE-Lined
Process Pumps

3796 i-FRAME®
Self-Priming
Process Pumps

NM 3196 i-FRAME®
Non-Metallic
Process Pumps

Parts List and Materials of Construction

Item Number	Part Name	Material			
		Ductile Iron/ CD4MCuN Trim	CD4MCuN	Alloy 20	Hastelloy B&C
100	Casing	Ductile Iron	CD4MCuN	Alloy 20	Hastelloy
101	Impeller	CD4MCuN	CD4MCuN	Alloy 20	Hastelloy
105	Lantern Ring (Not Illustrated)	Glass-Filled PTFE			
106	Stuffing Box Packing (Not Illustrated)	PTFE Impregnated Fibers			
108	Frame Adapter	Ductile Iron			
112	Thrust Bearing	Double Row Angular Contact Conrad**			
122	Shaft—Less Sleeve (Optional)	SAE4140	316SS	Alloy 20	Hastelloy
122	Shaft—With Sleeve	SAE4140			316SS
126	Shaft Sleeve	316SS	Alloy 20		Hastelloy
136	Bearing Locknut and Lockwasher	Steel			
168	Radial Bearing	Single Row Deep Groove			
184	Stuffing Box Cover (Packed Box)	Ductile Iron	CD4MCuN	Alloy 20	Hastelloy
184M	Seal Chamber (Mechanical Seal)	Ductile Iron	CD4MCuN	Alloy 20	Hastelloy
228	Bearing Frame	Cast Iron (Ductile Iron for STX Group)			
250	Gland	316SS	CD4MCuN	Alloy 20	Hastelloy
262	Repeller/Sleeve (Dynamic Seal Option)	CD4MCuN		Alloy 20	Hastelloy
264	Gasket, Cover-to-Backplate (Dynamic Seal)	PTFE			
265A	Stud/Nut, Cover-to-Adapter	304SS			
319	Oil Sight Glass	Glass/Steel			
332A	INPRO® Labyrinth Oil Seal (Outboard)	Stainless Steel / Bronze			
333A	INPRO® Labyrinth Oil Seal (Inboard)	Stainless Steel / Bronze			
351	Casing Gasket	Aramid Fiber with EPDM Rubber			
358A	Casing Drain Plug (Optional)	Steel	Alloy 20		Hastelloy
360	Gasket, Frame-to-Adapter	Buna			
370	Cap Screw, Adapter-to-Casing	Steel	304SS		
412A	O-ring, Impeller	Glass-Filled PTFE			
418	Jacking Bolt	304SS			
444	Backplate (Dynamic Seal Option)	Ductile Iron	CD4MCuN	Alloy 20	Hastelloy
469B	Dowl Pin	Steel			
496	O-ring, Bearing Housing	Buna Rubber			
761B	i-ALERT Condition Monitor	Stainless Steel / Epoxy			

Construction Details All dimensions in inches and (mm).

		STi	MTi	LTi	XLTi
Shaft	Diameter at Impeller	.75 (19)	1 (25)	1.25 (32)	1.5 (38)
	Diameter in Stuffing Box/Seal Chamber (Less Sleeve) (With Sleeve)	1.375 (35)	1.75 (45)	2.125 (54)	2.5 (64)
		1.125 (29)	1.5 (38)	1.875 (48)	2 (51)
	Diameter Between Bearings	1.5 (38)	2.125 (54)	2.5 (64)	3.125 (79)
	Diameter at Coupling	.875 (22)	1.125 (29)	1.875 (48)	2.375 (60)
	Overhang	6.125 (156)	8.375 (213)	8.375 (213)	9.969 (253)
	Maximum Shaft Deflection	0.002 (0.05)			
Sleeve	O.D thru Stuffing Box/Seal Chamber	1.375 (35)	1.75 (45)	2.125 (54)	2.5 (64)
Bearings	Radial	6207	6309	6311	6313
	Thrust	5306 A/C3	5309 A/C3	7310 BECBM	5313 A/C3
	Bearing Span	4.125 (105)	6.75 (171)	6.875 (164)	9.25 (235)
BigBore® Seal Chamber	Bore	2.875 (73)	3.5 (89)	3.875 (98)	4.75 (121)
Stuffing Box	Bore	2 (51)	2.5 (64)	2.875 (73)	3.375 (86)
Power Limits	HP (kW) per 100 RPM	1.1 (.82)	3.4 (2.6)	6.6 (4.9)	14.0 (10.5)
Maximum Liquid Temperature	Oil/Grease Lubrication without Cooling	350°F (177°C)			
	Oil Lubrication with Finned Cooler	500°F (260°C)			
Casing	Corrosion Allowance	.125 (3)			

Hydraulic Coverage

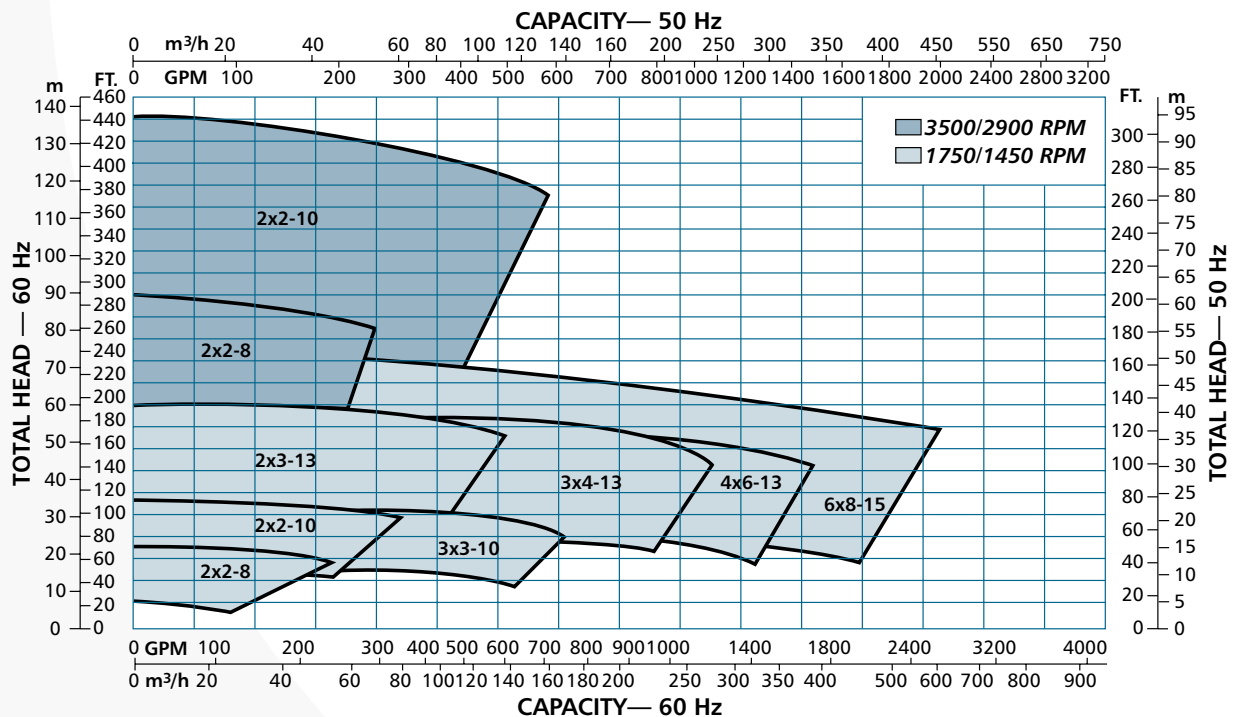
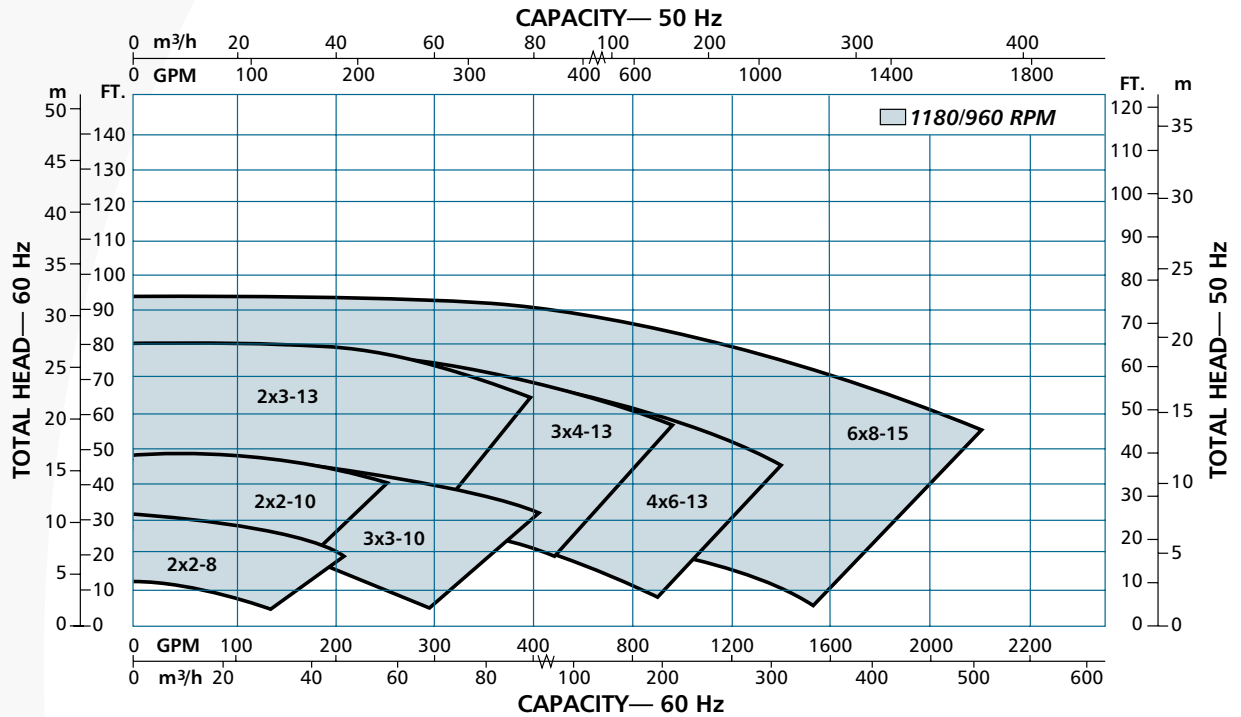

Options

i-ALERT[®]2 Equipment Health Monitor



What it Does:

Monitor

Tracks vibration, temperature & run-time hours 24/7/365.

Alarm

Checks every five minutes & alarms if equipment is outside normal operating conditions.

Trend

Stores data once per hour & on alarm for 30 days. Stores the weekly average, minimum & maximum up to 5 years.

Analyze

Diagnose machine faults with vibration tools Fast Fourier Transform (FFT) & Time Wave Form Analysis.

Environment

Rated for any industrial environment. IP67 water & dust resistant. Intrinsically Safe with a 3-year battery life (use dependent).

Wireless

Sync data via Bluetooth Smart enabled smartphones and tablets.



How it Works:

1. ACTIVATE

The *i-ALERT* devices are light activated by removing the sticker. The *i-ALERT*[®] device begins wirelessly broadcasting once activated.



2. AUTO CONFIGURATION

The *i-ALERT2* device averages the vibration over 25 hours of run-time and sets the alarm levels to 2 x average (0.1-1.5ips minimum). Temperature alarm default to 80°C (176°F)



OR

2. MANUAL CONFIGURATION

User manually sets the alarm thresholds via the *i-ALERT*[®] mobile application.



3. Monitor

The *i-ALERT* device checks every 5 minutes. If two consecutive readings are above alarm threshold the *i-ALERT* device will go into alarm.



Spend less time collecting data and more time fixing problems. The *i-ALERT*[®]2 mobile app has the ability to scan multiple *i-ALERT*[®]2 devices within range to quickly and safely inspect multiple machines.



Dashboard

Simple, intuitive dashboard to track vibration, temperature, run-time & battery life.



Trending

Trend vibration, temperature, & kurtosis to monitor any changes in the equipment operation.



BOM

Load the as built of materials based on the pump serial number.

Visit our website at
www.gouldspumps.com

Wherever you are, we're there too.

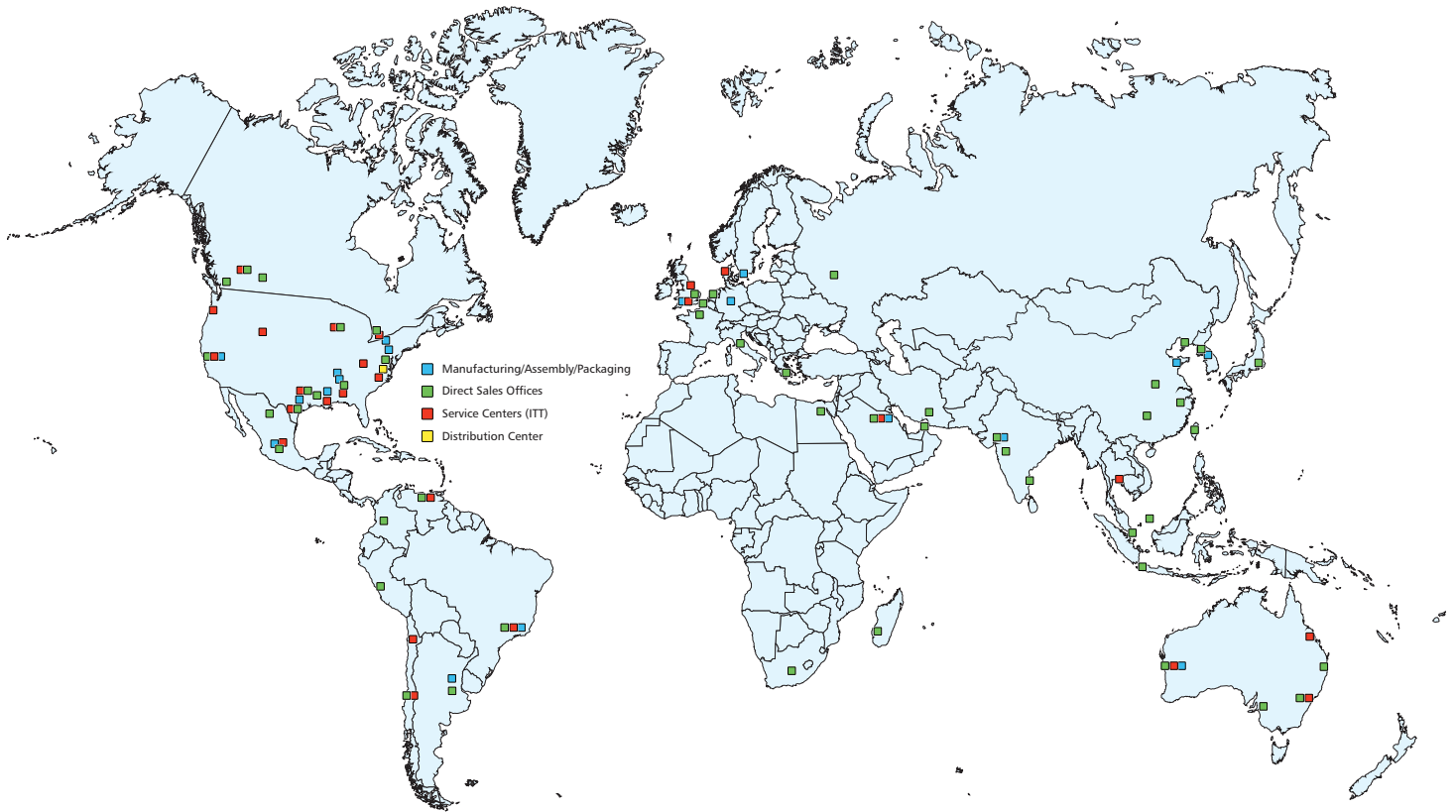

Reliability has no quitting time.

Building on over 160 years of Goulds Pumps experience, PRO Services provides an array of services focused on reducing equipment total cost of ownership (TCO) and increasing plant output, including predictive monitoring, maintenance contracts, field service, engineered upgrades, inventory management, and overhauls for pumps and other rotating equipment.

Your Total Solution For Equipment Life Cycle Optimization

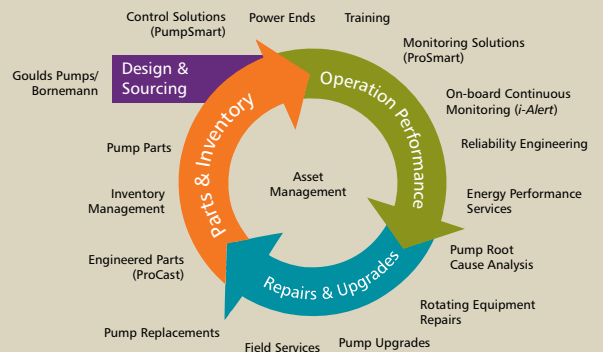

240 Fall Street
 Seneca Falls, NY 13148
www.itt.com

© 2017 ITT Corporation, Inc.

B.3196CV.en-US.2017-06